

Drawing No.  
P 7241

© CROWN COPYRIGHT

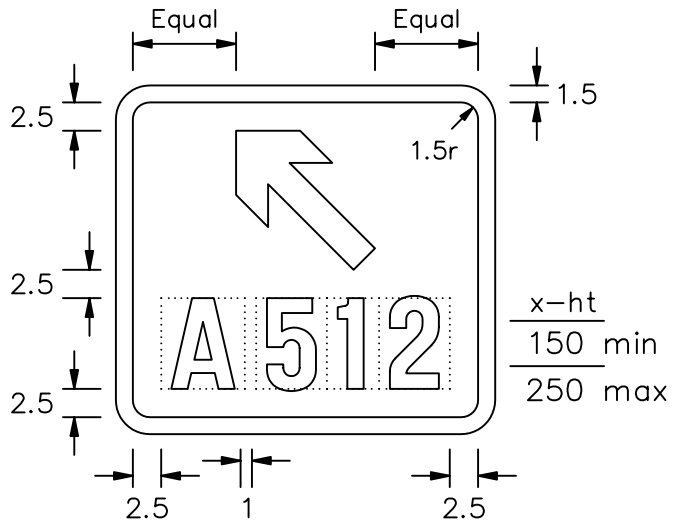
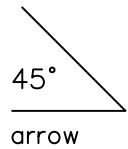

same x-heights  
for place name

- NOTES: 1. The place name is from the Transport Heavy alphabet and the route numbers from the Motorway (temporary) alphabet at the x-heights shown.
2. The tile outlines do not form part of the signs.
3. COLOURS : Background ----- YELLOW  
Legend, Arrow & Border --- BLACK
4. DIMENSIONS : x-heights are in millimetres, other dimensions are in stroke widths. (4sw = x-height)

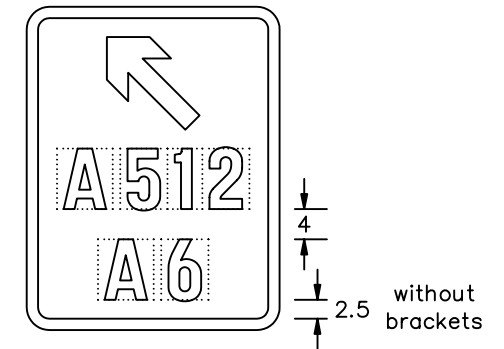
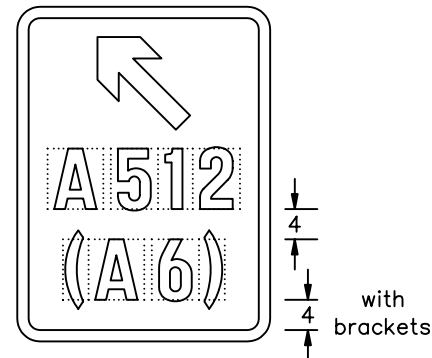
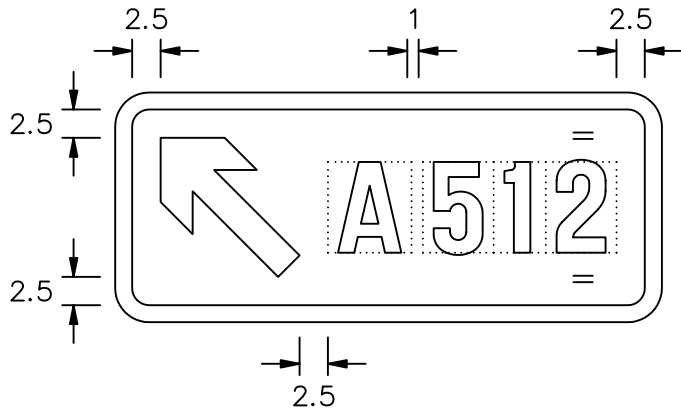
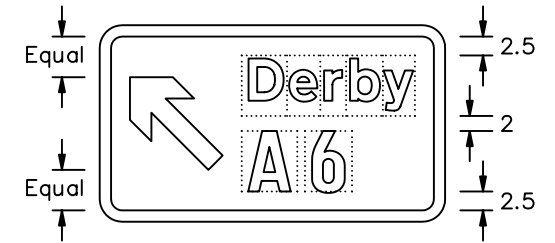
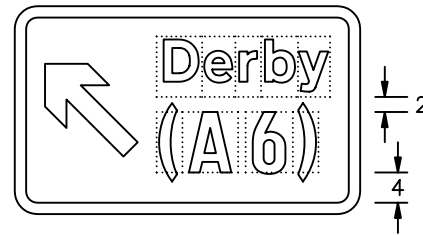

P7241

Arrow size : 16 x 8 stroke widths

Before using this drawing, confirm that it has not been superseded.

Department for  
**Transport**

Title: Road Works Signs  
TEMPORARY DIRECTION SIGN  
INDICATING MOTORWAY EXIT ROAD

Issue: Date: Drawn by:  
A: 27.1.05 R.M.  
B: Approved by:  
C: R.M.

Dimensions:  
SEE  
NOTE 4

Drawing No.  
P 7241